

Analog Devices Welcomes Hittite Microwave Corporation

NO CONTENT ON THE ATTACHED DOCUMENT HAS CHANGED



THIS PAGE INTENTIONALLY LEFT BLANK



**MicroSynth® INTEGRATED
SYNTHESIZER MODULE, 2 - 6 GHz**

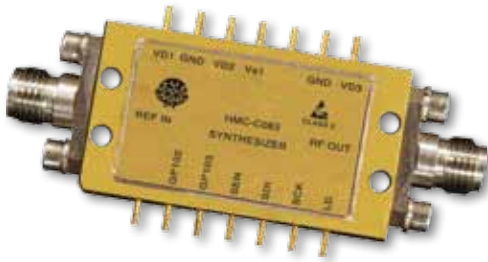

Features

- Extremely Compact, Broadband Synthesizer
- 24-Bit Step Size, 0.6 Hz Resolution
- Auto and Triggered Sweeper Functions
- Integrated Low Noise Voltage Regulators
- Hermetic Module
- Operating Temperature: -40°C to +85°C
- Class 2 ESD Rating (2 kV)

Typical Applications

- The HMC-C083 is ideal for:
- Military Radar, EW & ECM
 - Test & Measurement Equipment
 - Lab Instrumentation
 - Industrial/Medical Equipment

General Description

The HMC-C083 MicroSynth® is a fully integrated broadband synthesizer module that combines high performance SiGe, GaAs pHEMT, and InGaP HBT technologies into one compact hermetic package. The output frequency range is 2 to 6 GHz with an average output power of +17 dBm. In fractional-N mode, the HMC-C083 can realize step sizes as low as 0.6 Hz. The HMC-C083 also features fully integrated low noise regulators and an output buffer amplifier which results in superior pushing and pulling performance. This module has been designed to withstand harsh environments and can be upscaled to higher military standards upon request.

Functional Diagram

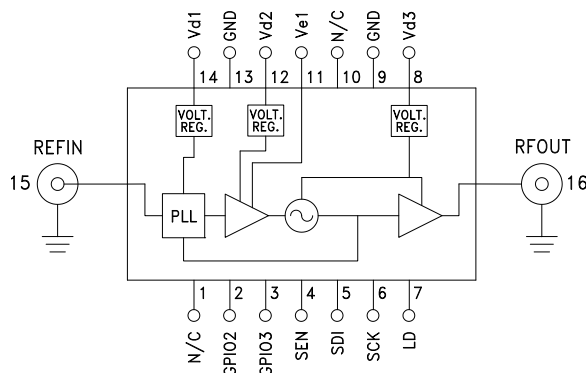

For theory of operation and register map refer to the MicroSynth® Operating Guide. To view the Operating Guide, please visit www.hittite.com and choose HMC-C083 from the "Search by Part Number" pull down menu.

Electrical Specifications, $T_A = +25^\circ C$, $V_{d1} = 3.6V$, $V_{d2} = 20V$, $V_{d3} = 6V$, $V_{e1} = -2V$

Parameter	Min.	Typ.	Max.	Units
Frequency Range		2 - 6		GHz
Power Output	14	17		dBm
Phase Noise @ 100 Hz Offset		-83		dBc/Hz
Phase Noise @ 1 kHz Offset		-88		dBc/Hz
Phase Noise @ 10 kHz Offset		-92		dBc/Hz
Phase Noise @ 100 kHz Offset		-94		dBc/Hz
Phase Noise @ 1 MHz Offset		-122		dBc/Hz
Reference Spur (@ 10 MHz)		-50	-45	dBc
Second Harmonic		-22		dBc
Third Harmonic		-25		dBc
Prescaler Coefficient (M)		1		
Phase Settling Time (<3 degrees), 10 MHz Step		500		μ s
Phase Settling Time (<3 degrees), 4 GHz Step		15		ms



MicroSynth® INTEGRATED SYNTHESIZER MODULE, 2 - 6 GHz

Electrical Specifications, (Continued)

Parameter	Min.	Typ.	Max.	Units
Output Return Loss		13		dB
Loop Bandwidth		150		kHz
Reference (comparison) Frequency		10		MHz
Reference Input Power	-6	0	12	dBm
Voltage Supply (Vd1)	3.3	3.6	12	V
Supply Current (Id1)		110	125	mA
Voltage Supply (Vd2)	19	20	20.5	V
Supply Current (Id2)		7	15	mA
Voltage Supply (Vd3)	5.5	6	12	V
Supply Current (Id3)		330	375	mA
Total DC Power Dissipation		2.5	6.5	W
Voltage Supply (Ve1) [1]	-6	-2	375	V
Supply Current (Ve1)		7	15	mA

Output Power vs. Frequency

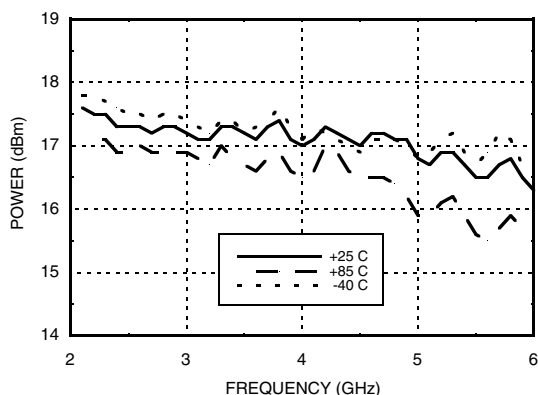

Phase Noise @ 2 GHz, Integer Mode

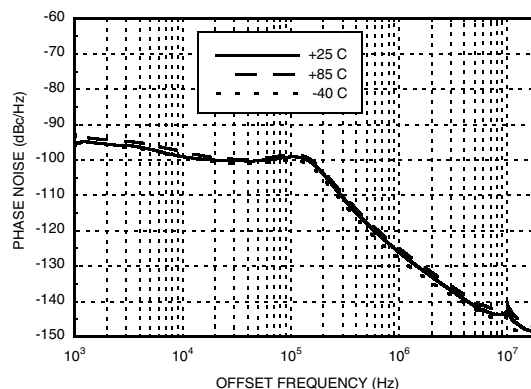

Phase Noise @ 4 GHz, Integer Mode

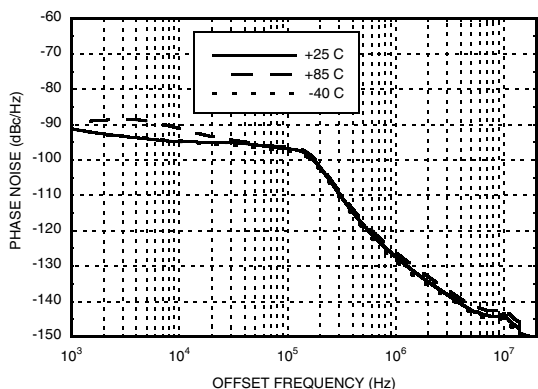

Phase Noise @ 4 GHz Integer vs. Fractional Mode

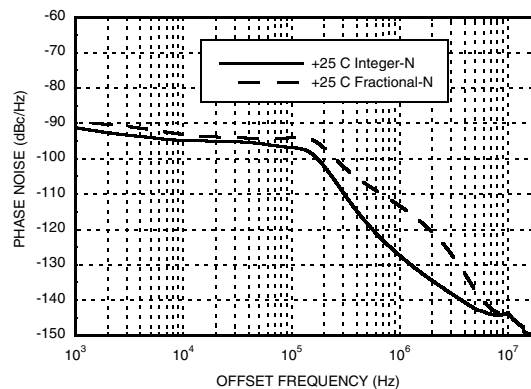

[1] Ve1 can be grounded if operation 2.1 - 6.0 GHz is acceptable



**MicroSynth® INTEGRATED
SYNTHESIZER MODULE, 2 - 6 GHz**

Phase Noise @ 6 GHz, Integer Mode

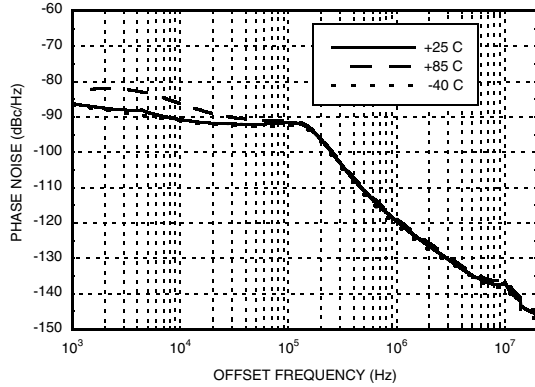

Reference Spur

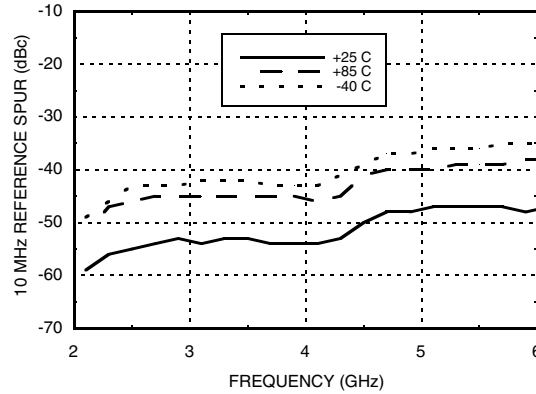

Second Harmonic vs. Frequency

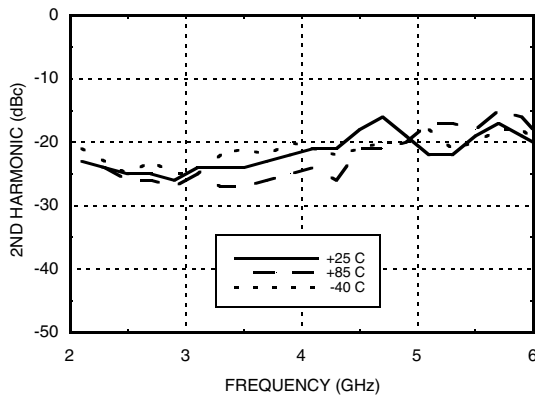

Third Harmonic vs. Frequency

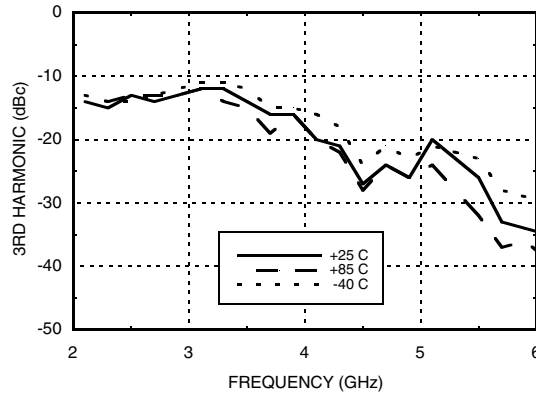

Fractional Spur Levels

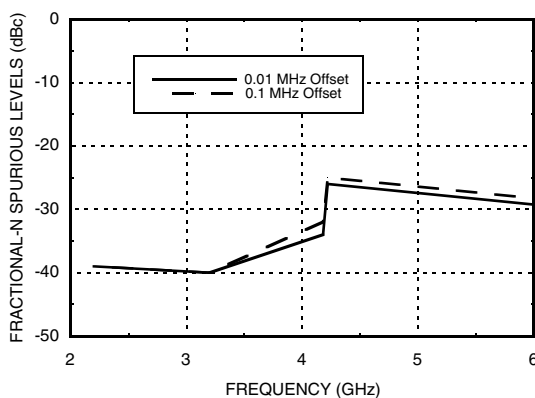

Absolute Maximum Ratings

Vd1	12 V
Vd2	20.5 V
Vd3	12 V
Ve1 (min)	-6 V
Continuous P _{diss} (T = 85°C)	6.5 W
Storage Temperature	-55 to +125 °C
Operating Temperature (backside)	-40 to +85 °C
SEN, CLK, SDI, GPI02, GPI03, LD	3.6V



**ELECTROSTATIC SENSITIVE DEVICE
OBSERVE HANDLING PRECAUTIONS**

Note that for operation below 4.2 GHz, register 1Bh should be set to 90h. In all other instances, register 1Bh should be set to 80h.

MicroSynth® INTEGRATED SYNTHESIZER MODULE, 2 - 6 GHz

Outline Drawing

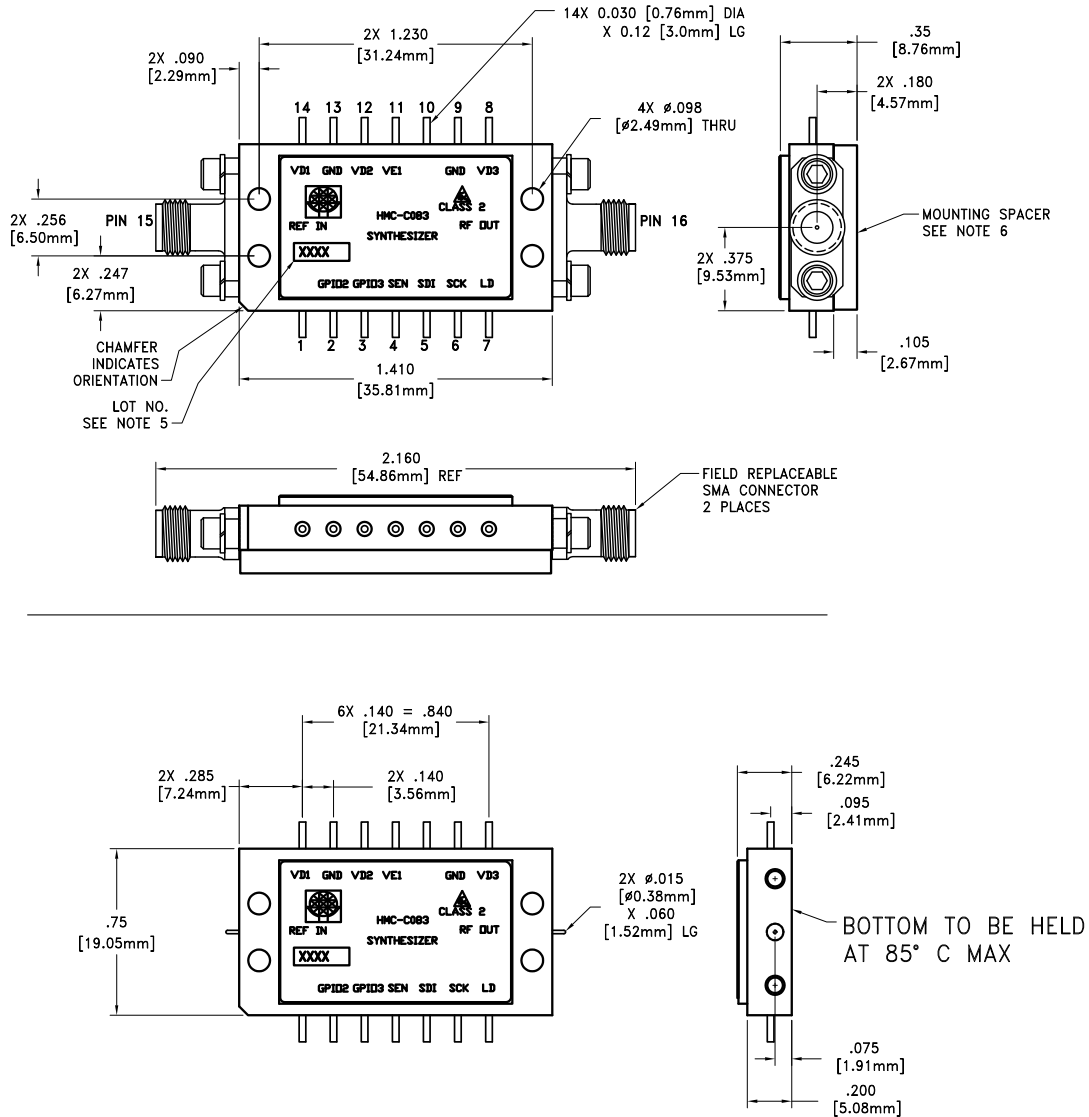

Package Information



Package Type	C-20
Package Weight ^[1]	16.5g
Spacer Weight	4.6g

[1] Does not include connectors, or mounting hardware

NOTES:

- 1.0 PACKAGE, LEADS, COVER MATERIAL: KOVAR™
- 2.0 FINISH: GOLD PLATE OVER NICKEL PLATE.
- 3.0 ALL DIMENSIONS ARE IN INCHES [MILLIMETERS].
- 4.0 TOLERANCES: UNLESS OTHERWISE SPECIFIED
- 4.1 .XX = ±0.02 [0.51]
.XXX = ±0.010 [0.25]
- 5.0 MARK LOT NUMBER ON 0.080 X 0.250 LABEL WHERE SHOWN WITH 0.030" MIN TEXT HEIGHT.
- 6.0 MOUNTING SPACER ALUMINUM 6061-T6 PER QQ-A-250/11, PLATING 0.0005 - 0.0007 ELECTROLESS NICKEL, SIZE 1.400 X 0.740 X 0.105. SURFACE PLANARITY 0.001 IN/IN ON MOUNTING SURFACES.

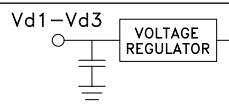
**MicroSynth® INTEGRATED
SYNTHESIZER MODULE, 2 - 6 GHz**
Pin Descriptions

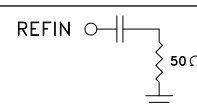
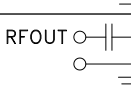
Pin Number	Function	Description	Interface Schematic
1, 10	N/C	The pins are not connected internally; however, all data shown herein was measured with these pins connected to RF/DC ground externally.	
2 - 3	GPIO2, GPIO3	General Purpose I/O with Tristate	See operating guide. [1]
4	SEN	Serial port Enable Input	See operating guide. [1]
5	SDI	Serial port Data input	See operating guide. [1]
6	SCK	Serial port Clock input	See operating guide. [1]
7	LD	Lock Detect	See operating guide. [1]
8, 12, 14	Vd3, Vd2, Vd1	Voltage Supply Pins	
9, 13	GND	These pins must be connected to RF/DC ground.	
11	Ve1	Note: Voltage supply pin may be grounded if operation 2.1 - 6.0 GHz is acceptable.	
15	REFIN	Reference input, 10 MHz nominal, 220 MHz maximum. Note: the comparison frequency (reference freq./R) may not exceed 75 MHz and the module performance is not specified at comparison frequencies other than 10 MHz.	
16	RFOUT	Synthesizer RF output.	

[1] To view the [Operating Guide](#), please visit www.hittite.com and choose HMC-C083 from the "Search by Part Number" pull down menu.



MICROWAVE CORPORATION v01.0111



HMC-C083

**MicroSynth® INTEGRATED
SYNTHESIZER MODULE, 2 - 6 GHz**

Notes: